

Data Sheet

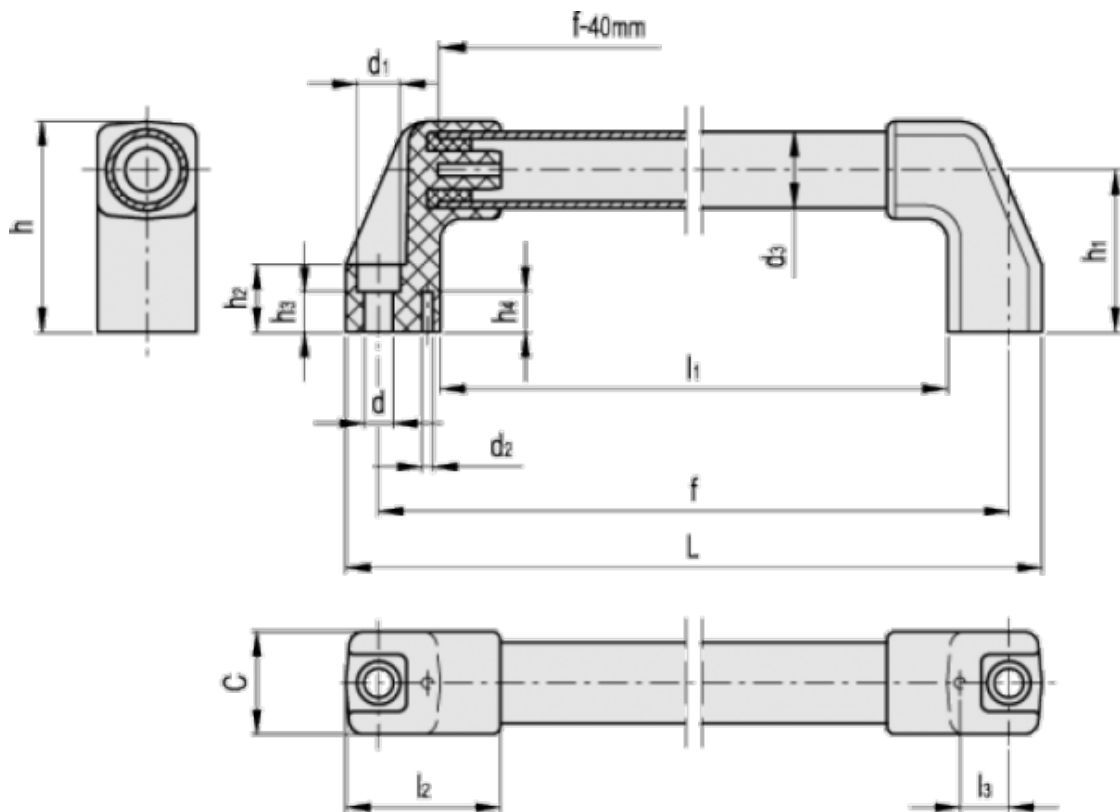

Article number: 2304037673
 Description: E+G Tubular handle
 M.1043/20-600-AN

Measures



c	= 28	h1 = 45	R = load at breakage in N = 1000
d	= 8.5	h2 = 18	
d1	= 13.5	h3 = 9.5	
d2	= 4	h4 = 15	
d3	= 20	L = 620	
E = Max . working load in N = 800		l1 = 562	
f	= 600	l2 = 47	
h	= 58	l3 = 13	